

LEAK CURRENT PROTECTED COMPACT SWITCH

Product Specifications

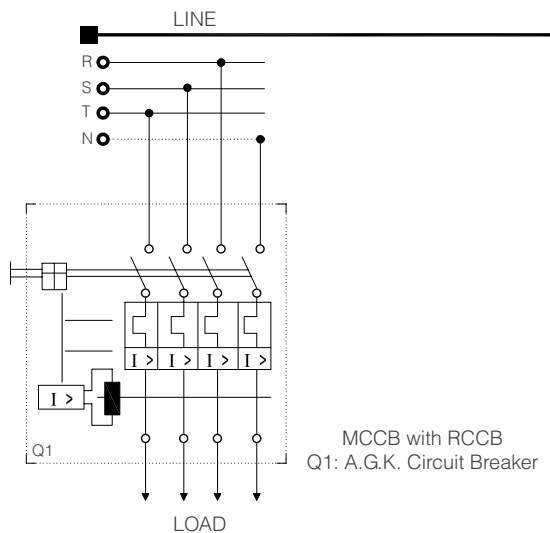

Wiring Diagrams



LEAK CURRENT PROTECTED COMPACT SWITCH

RSM

Technical Drawings

100 A Leak Current Protected Compact Switch

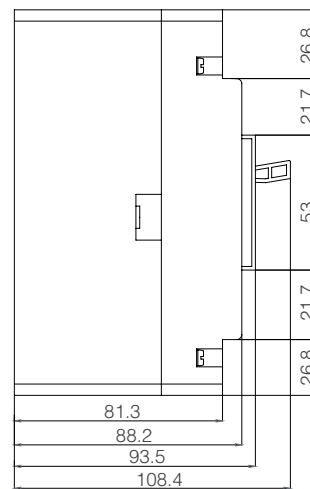
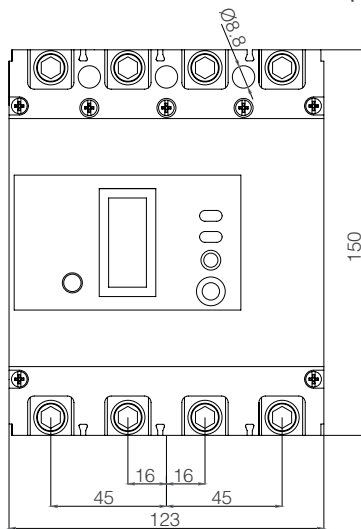

225 A Leak Current Protected Compact Switch

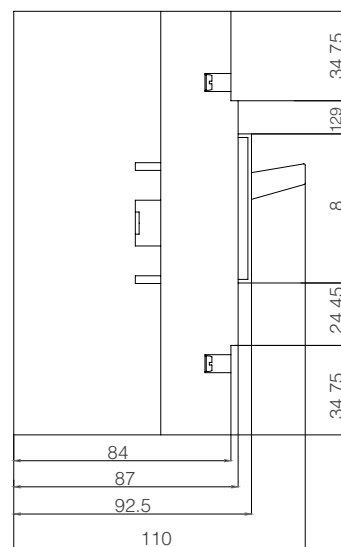
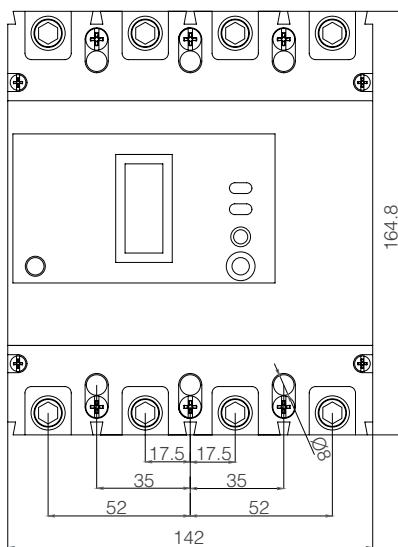

400 A Leak Current Protected Compact Switch

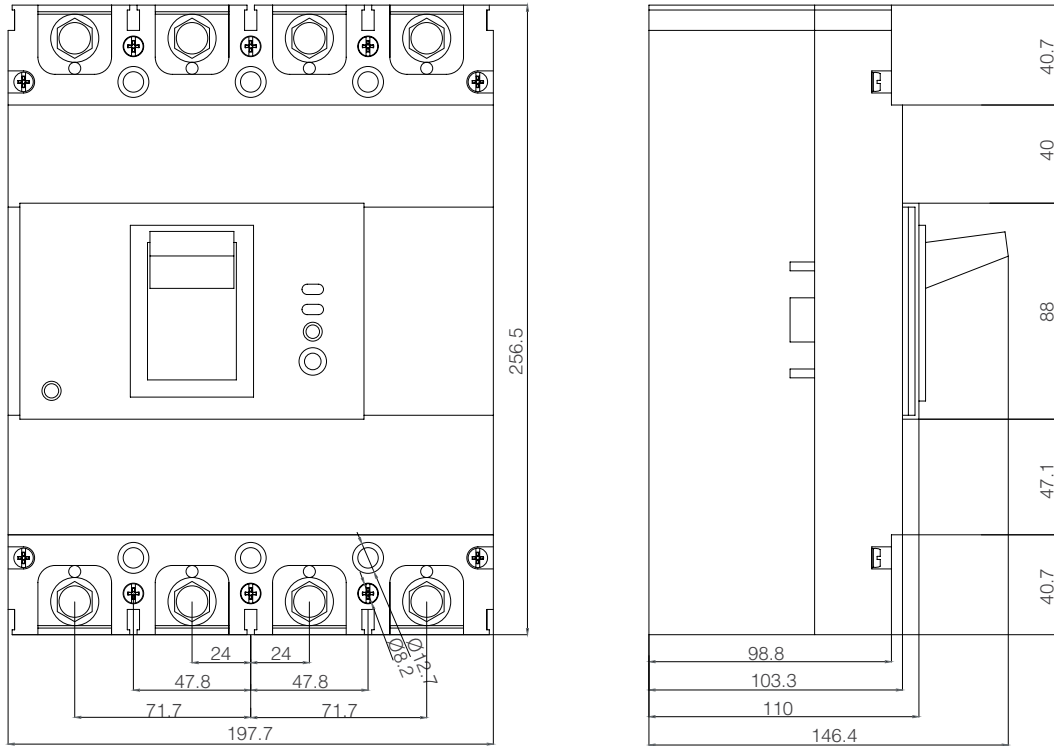

500 A, 630 A, 800 A Leak Current Protected Compact Switch

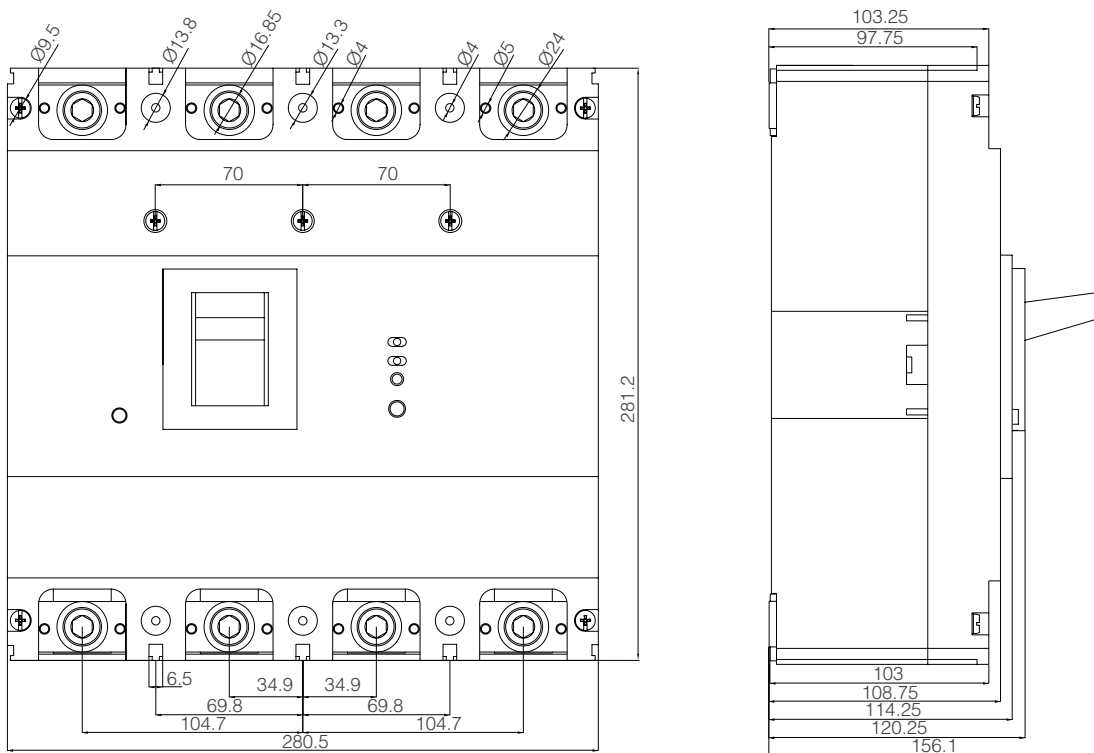

LEAK CURRENT PROTECTED COMPACT SWITCH 3kA



Leakage Case Circuit Breakers (with Shunt Releases)

Product Name	Code No	Breaking Capacity Icu (kA)	Threshold Current (mA)	Threshold Time (s)	Rated Current I _n (A)	Pcs in Box	Pcs Package
4 Pole	1242.06.1	35	30-100-300	0,1-0,3-0,5	40	1	8
	1242.06.2	35	30-100-300	0,1-0,3-0,5	50	1	8
	1242.06.3	35	30-100-300	0,1-0,3-0,5	63	1	8
	1242.06.4	35	30-100-300	0,1-0,3-0,5	80	1	8
	1242.06.5	35	30-100-300	0,1-0,3-0,5	100	1	8
	1242.06.6	35	30-100-300	0,1-0,3-0,5	125	1	8
	1242.06.7	35	30-100-300	0,1-0,3-0,5	160	1	8
	1242.06.8	35	30-100-300	0,1-0,3-0,5	225	1	8
	1242.06.9	50	100-300-500	0,1-0,3-0,5	250	1	2
	1242.06.10	50	300-500-1000	0,1-0,3-0,5	315	1	2
	1242.06.11	50	300-500-1000	0,1-0,3-0,5	400	1	2
	1242.06.12	50	300-500-1000	0,1-0,3-0,5	500	1	1
	1242.06.13	50	300-500-1000	0,1-0,3-0,5	630	1	1
	1242.06.14	65	300-500-1000	0,1-0,3-0,5	800	1	1

Leakage Case Circuit Breakers with (Shunt releases and mounted auxiliary contact blocks)

Product Name	Code No	Breaking Capacity Icu (kA)	Threshold Current (mA)	Threshold Time (s)	Rated Current I _n (A)	Pcs in Box	Pcs Package
4 Pole	1242.07.1	35	30-100-300	0,1-0,3-0,5	40	1	8
	1242.07.2	35	30-100-300	0,1-0,3-0,5	50	1	8
	1242.07.3	35	30-100-300	0,1-0,3-0,5	63	1	8
	1242.07.4	35	30-100-300	0,1-0,3-0,5	80	1	8
	1242.07.5	35	30-100-300	0,1-0,3-0,5	100	1	8
	1242.07.6	35	30-100-300	0,1-0,3-0,5	125	1	8
	1242.07.7	35	30-100-300	0,1-0,3-0,5	160	1	8
	1242.07.8	35	30-100-300	0,1-0,3-0,5	225	1	8
	1242.07.9	50	100-300-500	0,1-0,3-0,5	250	1	2
	1242.07.10	50	300-500-1000	0,1-0,3-0,5	315	1	2
	1242.07.11	50	300-500-1000	0,1-0,3-0,5	400	1	2
	1242.07.12	50	300-500-1000	0,1-0,3-0,5	500	1	1
	1242.07.13	50	300-500-1000	0,1-0,3-0,5	630	1	1
	1242.07.14	65	300-500-1000	0,1-0,3-0,5	800	1	1



400 A MCCB with RCCB



225 A MCCB with RCCB



100 A MCCB with RCCB